

EP00008 / G

EXPLOSION SAGITTA SI				Plan No.
				EP00008 / G
Scale: 1:7	Drafted	Verified	Confirmed	1/5
Date	28/10/2010	22/07/2024	22/07/2024	
Initials	AS	AZ	AS	

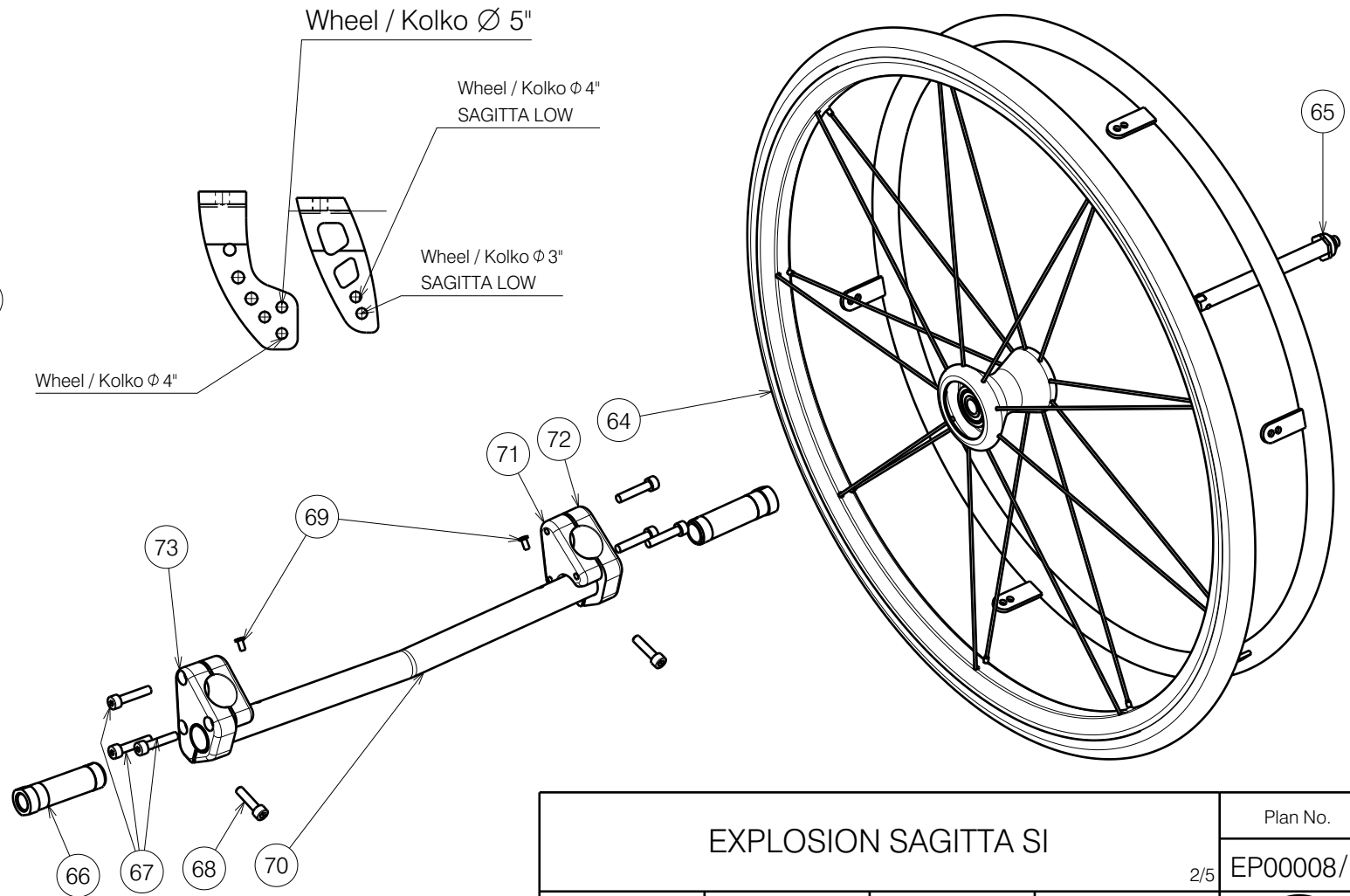

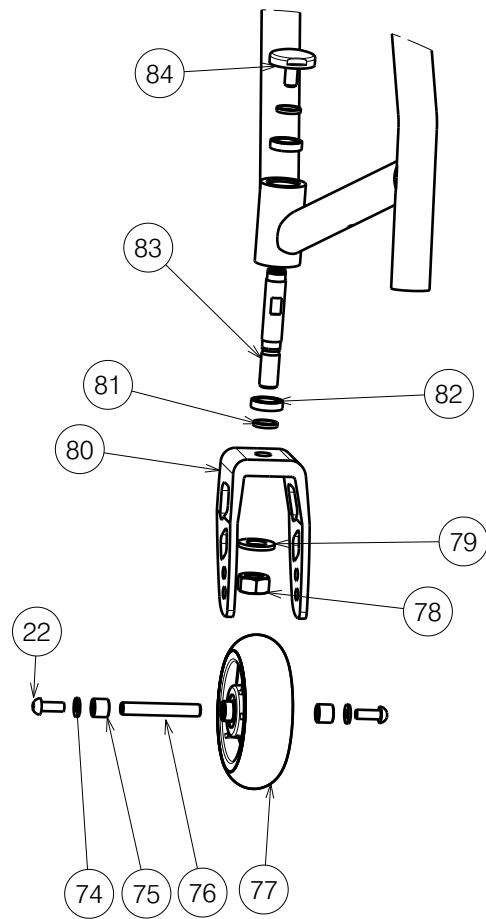

EP00008 / G

EXPLOSION SAGITTA SI				Plan No.
				2/5 EP00008/ G
Scale: 1:5	Drafted	Verified	Confirmed	
Date	28/10/2010	22/07/2024	22/07/2024	
Initials	AS	AZ	AS	

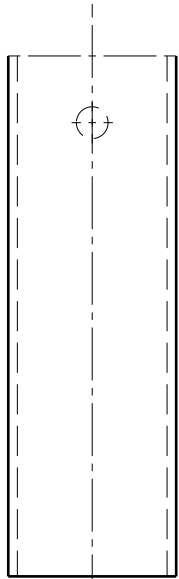

0°

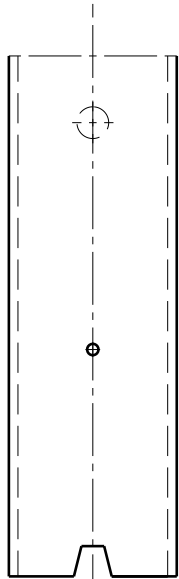

2°

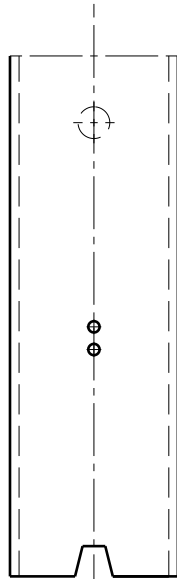

4°

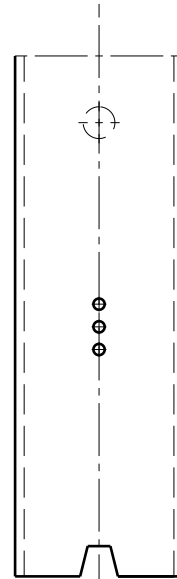

6°

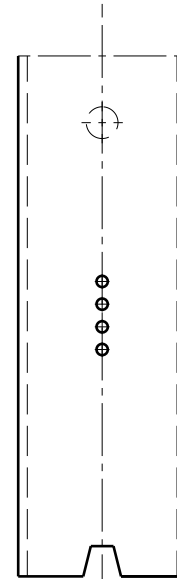

8°

EP00008 / G

EXPLOSION SAGITTA SI				Plan No.
				EP00008 / G
Scale: 1:7	Drafted	Verified	Confirmed	
Date	28/10/2010	22/07/2024	22/07/2024	
Initials	AS	AZ	AS	

3/5

Material			
No.	Plan	Article	Number
1	YP02823	28110(Long)	1
	YP02816	28100	1
2	YP02822	28111(Long)	1
	YP02817	28101	1
Width 36 cm			
3	YP02821	28112(Long)	1
	YP02814	28099	1
4	YP01734	18815..(22-27)	1
	YP01732	18821..(27-42)	1
5	YP01351	18559..	1
Width 38 cm			
3	YP02827	28115(Long)	1
	YP02832	28120	1
4	YP01740	18816..(22-27)	1
	YP01733	18822..(27-42)	1
5	YP01263	18536..	1
Width 40cm			
3	YP02828	28116 (Long)	1
	YP02833	28121	1
4	YP01741	18817..(22-27)	1
	YP01694	18823..(27-42)	1
5	YP01298	18560..	1
Width 42cm			
3	YP02829	28117(Long)	1
	YP02834	28122	1
4	YP01742	18818..(22-27)	1
	YP01735	18824..(27-42)	1
5	YP01299	18561..	1
Width 44cm			
3	YP02830	28118(Long)	1
	YP02835	28123	1
4	YP01743	18819..(22-27)	1
	YP01736	18825..(27-42)	1
5	YP01379	18562..	1

Material			
No.	Plan	Article	Number
Width 46cm			
3	YP02831	28119(Long)	1
	YP02836	28124	1
4	YP01744	18820..(22-27)	1
	YP01737	18826..(27-42)	1
5	YP01383	18563..	1
6	YP01435	18624(36-40)	1
	YP01450	18652(42-46)	1
7	YP01328	18653..	2
8	YP01370	18651..	2
9	YP01257	18533..(27-32)	2
	YP01438	18631..(32-37)	2
	YP01439	18632..(37-42)	2
10	YP01440	18633..(22-27)	2
	YP02704	28109(Long)	2
11	YP02705	28108	2
	YP02851	28772	2
12	YP01715	18767	1
13	YP01689	18766	1
14	YP02808	28114	1
15	YP02807	28113	1
16	YP02343	18999	2
17	YP02344	28001	4
18	YP02345	28002	2
19	X000989	1004539	10
20	M6X20	1006999	6
21	M6X35	2991297	4
22	M6X16	1008459	4
23	Rivet4X14	1001584	7
24	M6X45	2991311	2
25	M6X45	1992899	2

Material			
No	Plan	Article	Number
26	M6X40	1006111	2
27	XP00328	18540	4
28	M6	2990164	4
29	M6	1001680	6
30	DIN125A	1000973	2
31	XP00357	2990300	4
32	Cap D19	1001602	2
33	D4.8x19 DIN 7983	1001534	2
34	X001473	1002994	2
35	Hand Grip	2990351	2
36	Y000462	F000050	2
37	X000273	G0606	2
38	Cap D25	1001608	2
39	GN 717-6-AK	2990301	2
40	XP00412	2990456	4
41	Rubber	1003299	1m
42	XP00366	2990331	4
43	M6X12	1005949	2
44	XP00350	18550	2
45	MBL 673073	2990320	1
	MBL 673074	2990319	1
46	MBL 674001	2990321	2
47	L	1992929	1
	P	1992930	1
48	X0002115	15526	1
	X0002116	15527	1
49	D6xD18x1.6	1997328	2
50	XP00369	GP00045	4
51	XP00422	2990457	4
52	XP00365	18553	4
53	XP00405	GP00054	2

EP00008 / G

EXPLOSION SAGITTA SI				Plan No.
				4/5 EP00008/ G
Scale: ---	Drafted	Verified	Confirmed	
Date	28/10/2010	22/07/2024	22/07/2024	
Initials	AS	AZ	AS	

Material			
No.	Plan	Article	Number
Width 46cm			
54	XP00392	GP00055	2
55	XP00346	1853900	2
56	M10 DIN125	1001557	2
57	M8	1001682	2
58	M8 DIN126	1001554	2
59	D6	2990462	2
60	XP00390	2990459	2
61	XP00345	2990310	2
62	M5X5	1991323	6
63	XP00535	2990627	2
64	Wheel	2990317	2
65	MBL628278	2990330(24")	2
	MBL618353	1991876(22")	2
66	XP00386	2990417	2
	XP00454	2990349	2
67	M6X30	1001432	6
68	M6X25	1001494	2
69	D4X8	2990307	2

Width 36 cm				
No.	Plan	Article	Angle	Number
70	YP01382	18569..	0°	1
	YP01387	18571..	2°	1
	YP01385	18570..	4°	1
	YP01348	18572..	6°	1
	YP01389	18573..	8°	1
Width 38 cm				
	YP01390	18586..	0°	1
	YP01268	18534..	2°	1
	YP01392	18587..	4°	1
	YP01394	18588..	6°	1
	YP01396	18589..	8°	1
Width 40 cm				
	YP01056	18590..	0°	1
	YP01399	18591..	2°	1
	YP01216	18592..	4°	1
	YP01401	18593..	6°	1
	YP01403	18594..	8°	1
Width 42 cm				
	YP01407	18595..	0°	1
	YP01409	18596..	2°	1
	YP01249	18597..	4°	1
	YP01411	18598..	6°	1
	YP01331	18599..	8°	1

Width 42 cm			
No	Plan	Article	Angle
Width 44 cm			
70	YP01412	18605..	0°
	YP01414	18606..	2°
	YP01416	18607..	4°
	YP01418	18608..	6°
	YP01420	18609..	8°
Width 46 cm			
	YP01421	18610..	0°
	YP01423	18611..	2°
	YP01425	18612..	4°
	YP01427	18613..	6°
	YP01429	18614..	8°
Material			
No	Plan	Article	Number
71	XP00352	1862654	2
72	XP00351	1862754	1
73	XP00353	1862554	1
74		1001564	4
75	XP00680	2990917	4
76	XP00341	1854900	2
77	KNSF3"	2990568	2
	KNSF4"	2990348	2
	KNSF5"	2990328	2
78	M12X1,25	1003369	2
79		1993362	2
80	XP00385	18707(Low)	2
	XP00336	18628	2
81	X000188	G0785	4
82		1003276	4
83	XP00338	18538	2
84	XP00340	18548	2
85	M6 DIN127B	1004414	6

EXPLOSION SAGITTA SI				Plan No.
				5/5 EP00008/ G
Scale: ---	Drafted	Verified	Confirmed	
Date	28/10/2010	22/07/2024	22/07/2024	
Initials	AS	AZ	AS	

EP00008 / G